

Charisma™ SEG Slim Profile Light Box - XSL Tool Free Corners

Page 1 - Assemble the Frame

All frame extrusion ends are marked with a number sticker.

1. Lay out the frame on a clean flat surface and matching section numbers, 1 next to 1, 2 next to 2, 3 next to 3, etc.
2. At each connection point, there should be 2 latches and 2 catches. Slide the extrusion into it's mating half slowly and carefully. Then lift up the latch handle, extend the latch's loop over the catch, and push down the latch handle to secure. You should feel it snap closed. Repeat this step for the next latch. NOTE - If a corner or straight connection will not come together, check to ensure the frame sections are lined up correctly. If they are, you might need to open both latches, and make sure the LOOP of the latch is aimed away from the connection point first so that it does not prevent the two halves from coming together. Then, after the extrusion halves are nice and tight together, then re-latch both latches at the connection point.
3. Repeat step 2 for the remaining corners and any straight breaks in the frame (if applicable).
4. Check to ensure all corners are nice and tight. If any seem to have noticeable gaps or are uneven, partially unlatch, hold tight together as best as possible, and re-latch.
5. If provided, place the spanner bar bracket into frame channel, matching the sticker color of the spanner bar with the sticker on the frame. Use the two thumb screws to expand the bracket inside the channel to secure it in place, making sure to attach the spanner to the section of the extrusion shown in the illustration below.

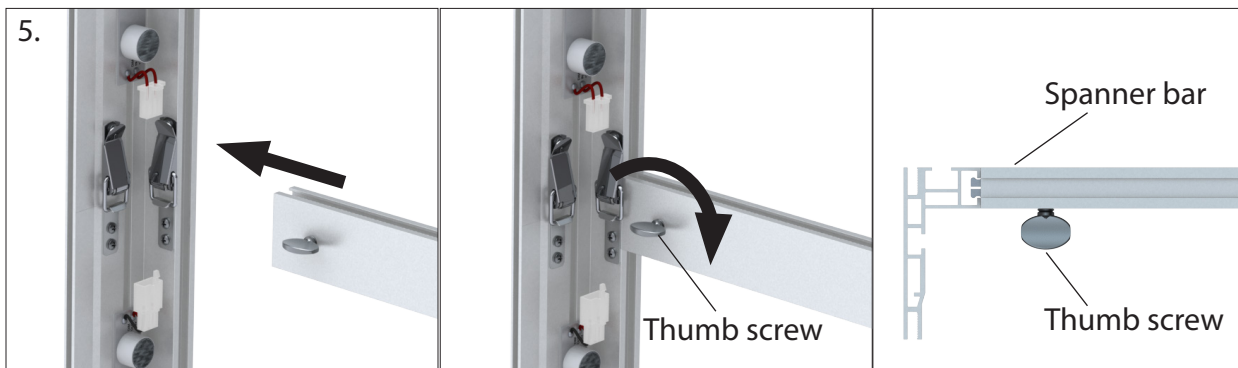
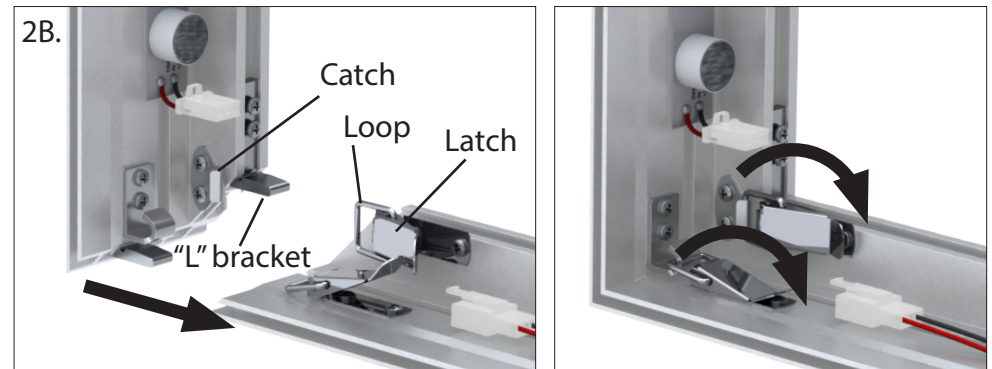
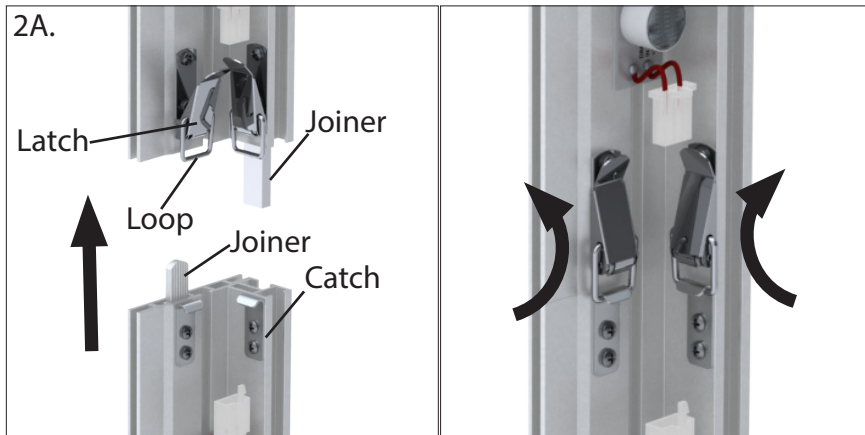
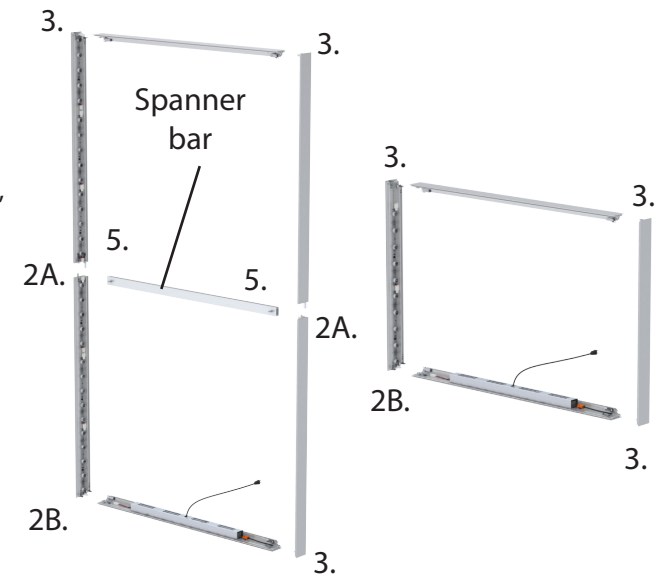

Charisma™ SEG Slim Profile Light Box - XSL Tool Free Corners

Page 2 - Connect Electrical Components

1. At each break in the extrusion, identify the orange or white electrical connector. Then connect the white female connectors to their matching male connectors and the orange female connector to their matching male connector. The connectors must fully "click" together.
2. It is normal for the last female white connector to be unconnected to anything else.
3. If there are multiple cables, connect those with matching colors.

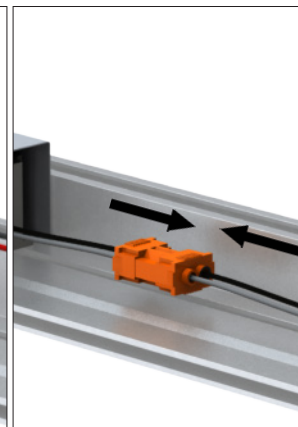
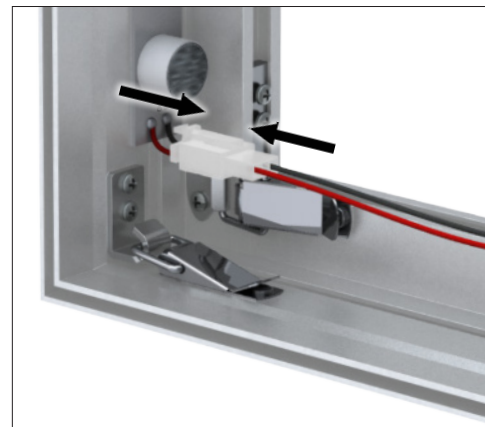
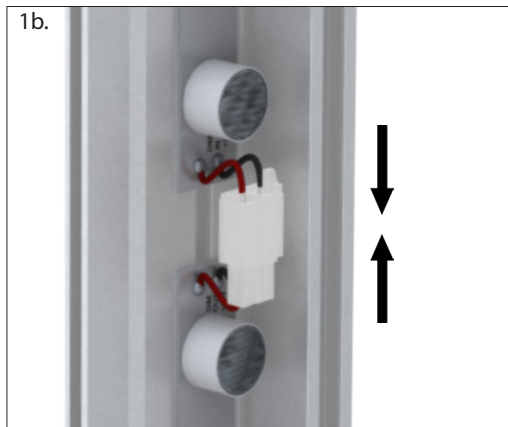
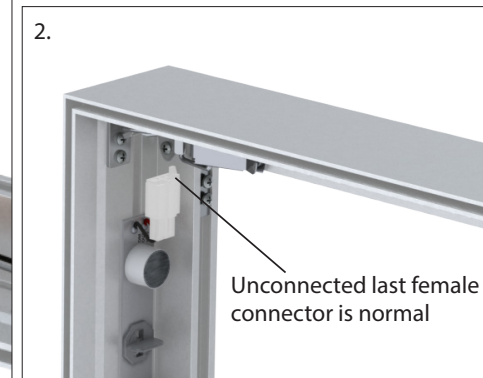
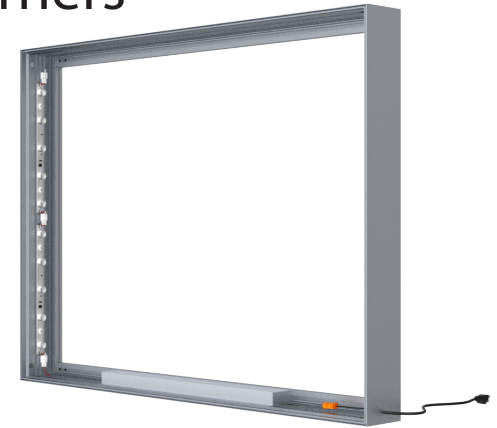

ELECTRICAL NOTE:

This sign is intended to be installed in accordance with the requirements of Article 600 of the National Electrical Code and/or other applicable codes. This includes proper grounding and bonding of the sign.

Charisma™ SEG Slim Profile Light Box - XSL Tool Free Corners

Page 3 - Install Fabric Backer

Most frames will use a fabric backer (optional) to reflect light forward to the graphic.

1. Identify the **back** channel of the extrusion, as shown below.
2. To install the fabric backer in the back of the extrusion, take the corner A with the pull tag on it and press about 6"-10" of silicone into the frame channel. Repeat for the opposite corner B. Repeat for the next corner C. Lastly, repeat for the final corner D.
3. After all corners are pressed in, press the silicone into the frame channel at the mid-points on all four sides.
4. Press silicone into frame evenly between the corner and midpoints.
This prevents the fabric backer from bunching up or stretching too much and will ensure a smooth and tight fit.
5. To remove the fabric backer from the frame, simply pull up on the pull tag.

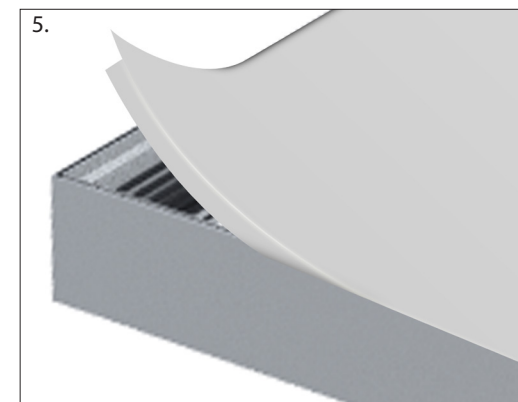
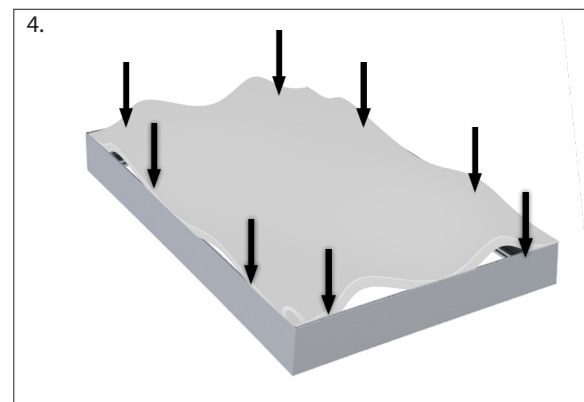
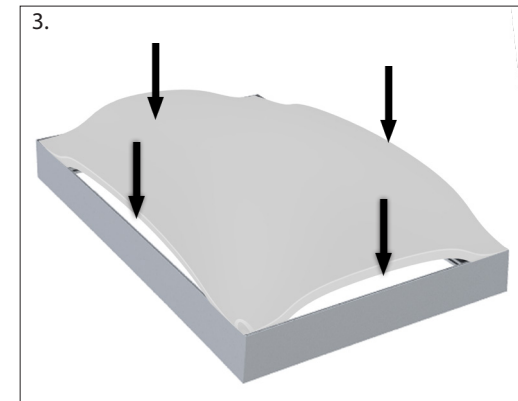
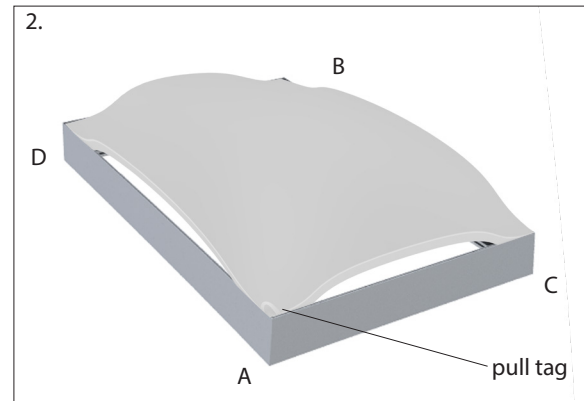
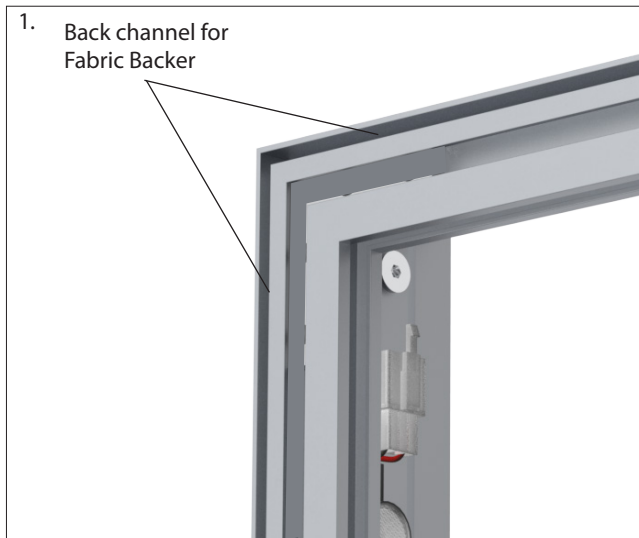
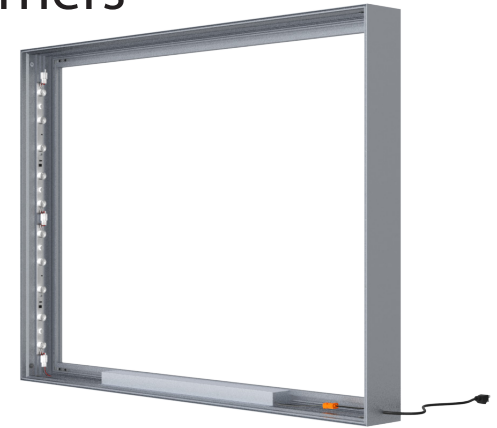

Charisma™ SEG Slim Profile Light Box - XSL Tool Free Corners

Page 4 - Mounting

1. WALL MOUNT: *Drill mounting holes in the frame as needed, to align with the EXISTING WALL STUDS. Using an X-acto blade or hole puncher, puncture or cut small holes into the white backing graphic to match the holes just drilled in the frame, then mount to the wall (Mounting screws and anchors not provided - ensure the appropriate type for your wall).*
2. HANG: the frame using the pre-mounted eyebolts, after installing graphic (see next page for graphic installation).

CAUTION: Always ensure the frame is secured strongly without risk of falling before completing the installation.

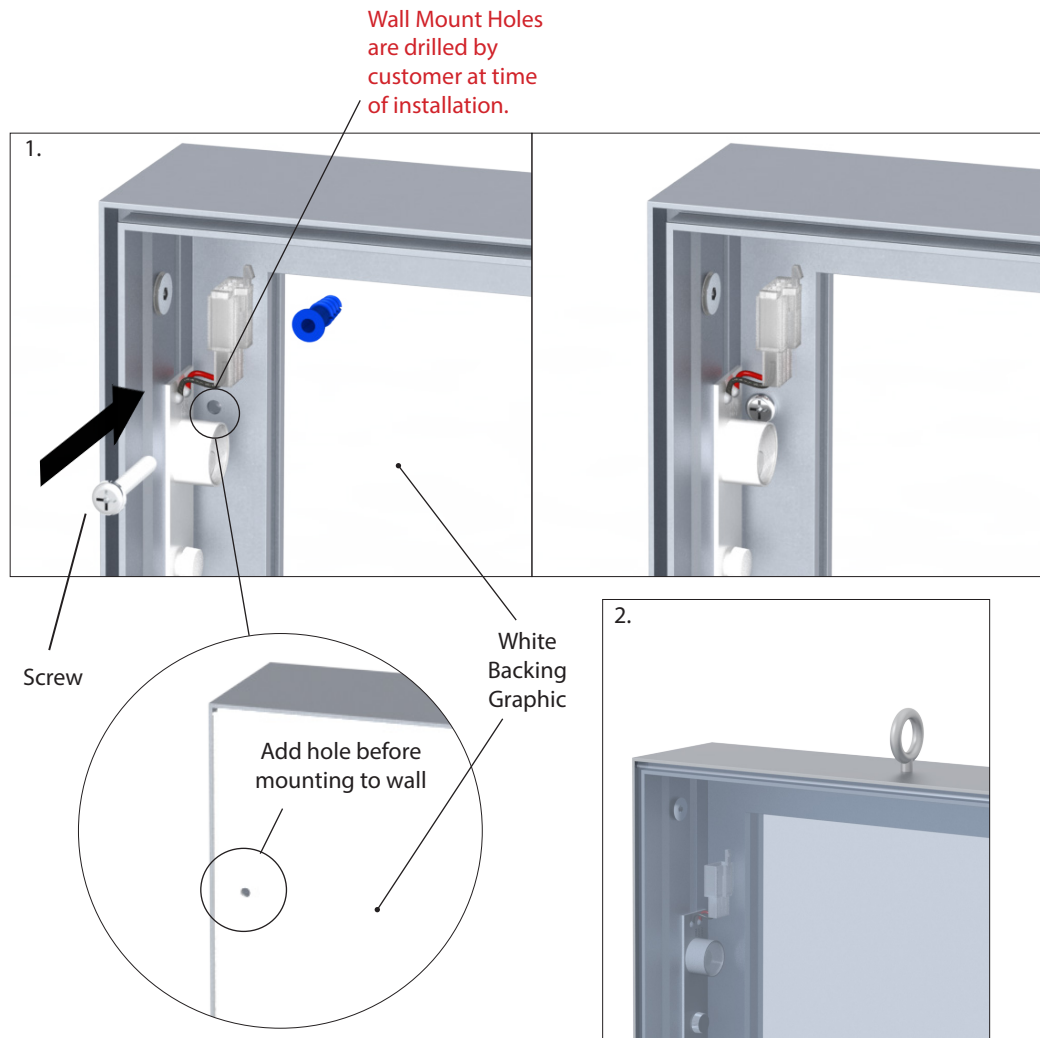
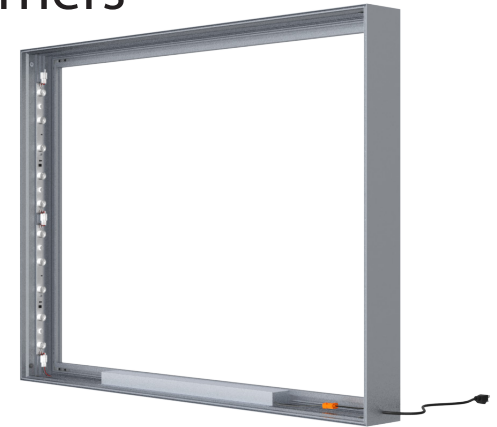

Charisma™ SEG Slim Profile Light Box - XSL Tool Free Corners

Page 5 - Install the Graphic

1. Plug frame into wall outlet.
2. To install the graphic, take the corner with the pull tag on it and press about 6"-10" of silicone into the frame channel corner A. Repeat for the opposite corner B. Repeat for the next corner C. Lastly, repeat for the final corner D.
3. After all corners are pressed in, press the silicone into the frame channel at the mid-points on all four sides.
4. Press silicone into frame evenly between the corner and midpoints.
This prevents the graphic from bunching up or stretching too much and will ensure a smooth and tight fit.
5. To remove the graphic from the frame, simply pull up on the pull tag.

NOTE: Model shown below may differ from your model, but assembly instructions remain the same.

